

ACCUTEX TECHNOLOGIES CO., LTD.

NO.20,Jingke Rd, Nantun District, Taichung City 40852,Taiwan.

+886-4-2359-9688

+886-4-2359-7266

www.accutex.com.tw

sales@accutex.com.tw

info@accutex.com.tw



The Pioneer Of Taiwan Wire Cut EDM

Wire Cut EDM

The Best Solution of CNC Wire EDM Technology

AP AZ AU GA Series

Speed / Accuracy / Roughness / Stability



www.accutex.com.tw



Facebook



AccuteX



Maintenance service

Environmental Requirements

Power Source AC220V / AC380V / AC400V / AC415V $\pm 5\%$:3 Phases 50/60Hz ± 1 Hz

Temperature 20 ± 1 °C or 25 ± 1 °C : less than 75%RH

Environment

1. The machine should not be placed near punching machine,drilling machine or any interfering sources.
2. The machine should not be placed near heat treatment or electroplate systems.
3. The machine be placed in an airtight room to keep dust out.
4. Before machine positioning, pay attention to machine movement during operation and the space needed for maintenance.
5. Solid foundation of horizontal error should be less than 20 μ m.

Earth construction Earth resistance below 10 Ω : separate the earth terminal with other machines.

Pneumatic pressure 6 kg / cm² (Applicable for machine with AWT system)

*All the specifications are subject to change without prior notice.



2011年
小巨人獎



2012年
國家磐石獎



經營技術典範獎
BEST PRACTICE AWARD FOR OPERATIONS TECHNOLOGY
國家品質獎-卓越貢獻獎

2018年
國家品質獎



52Q22131
ISO 9001 : 2015



台灣精品 2023
TAIWAN EXCELLENCE

www.accutex.com.tw

The whole machine serial lineup

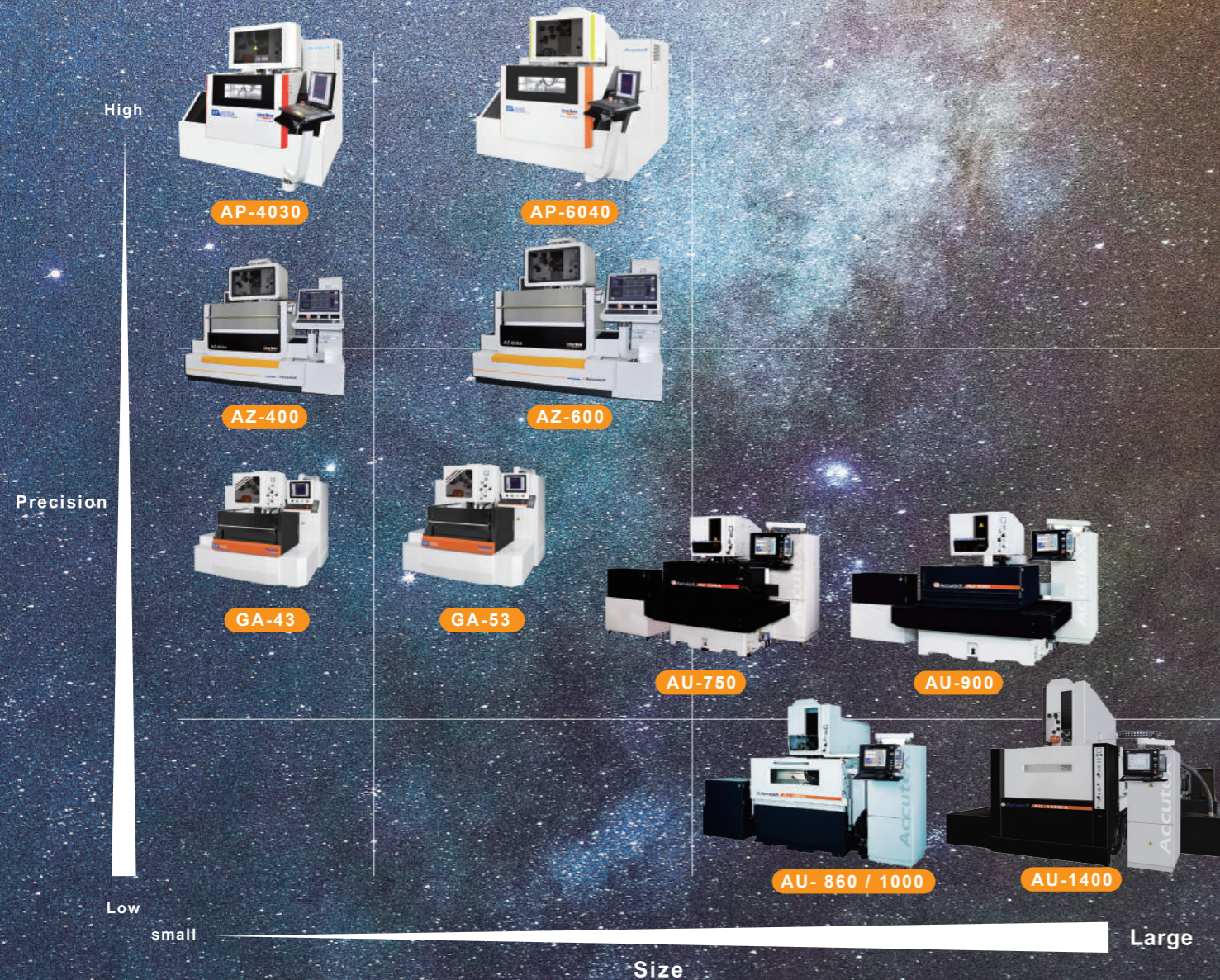

HIGH-TECH INDUSTRY

High-tech industrial Applications

- | Aerospace Application
- | Medical parts
- | Electric vehicle
- | Molds

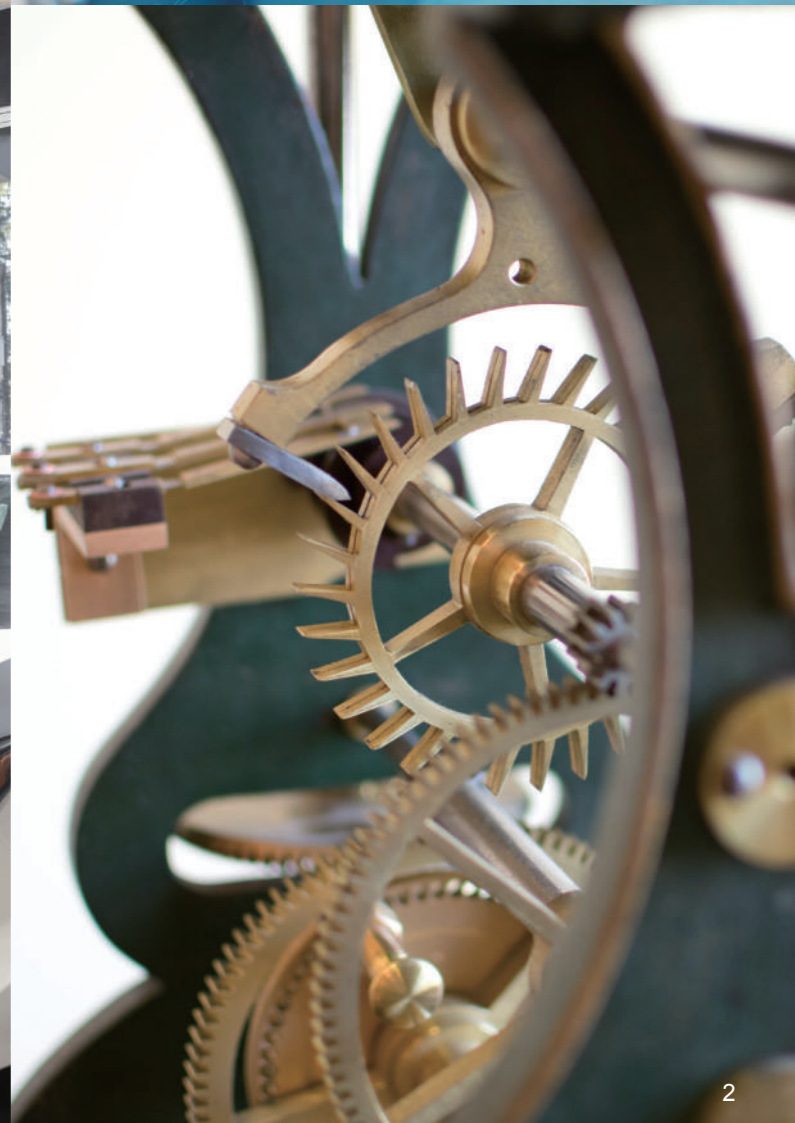

Machine Structure

AZ Series

AZ series has a "Direct Force" design on the concept of X/Y axes linear guideway blocks keep staying in a straight line. The working table is supported by casting bases. AZ series is suitable for precision mold cutting within small/medium strokes.

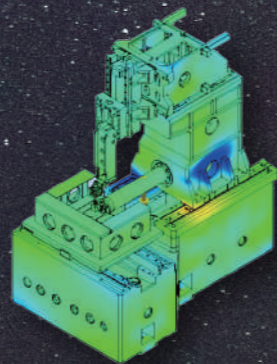

AP Series

AP series casting has a compound table design by Y-axis column moving. The center of gravity is always located between 2 linear guideways of X axis table. X and Y axes are independent without accumulation error for less deformation by FEA (Finite Element Analysis). Improved maximum loading weight is up to 1000kgs. The Bi-repeatability is less than 2.5µm after 5 times laser calibration.

New Windows controller



Motor Torque Monitoring System

100% automatic torque measurement of machine full stroke

Press one single key to kick off the auto-measurement of the full stroke torque, one single execution to realize the torque status of the full stroke operation. Ensures this is interference-free machining on the machine.

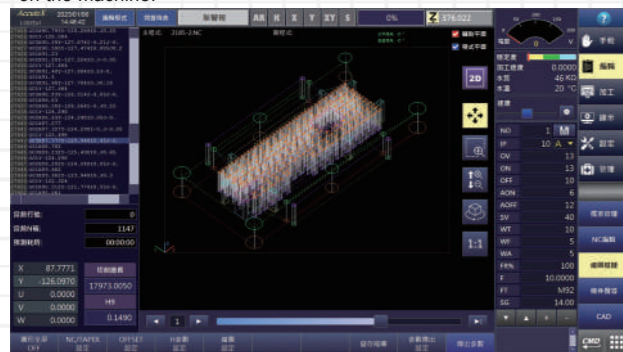

Fast drawing performance

Drawing speed increased by 300% and is able to have 3D full viewing

For large-scale programs, drawing smoothly and quickly, switch between 2D / 3D viewing, and viewing all detail position. In 3D mode, drag to change the viewing angle, and use the mouse wheel to zoom, clearly check the cutting path and improve the processing quality.

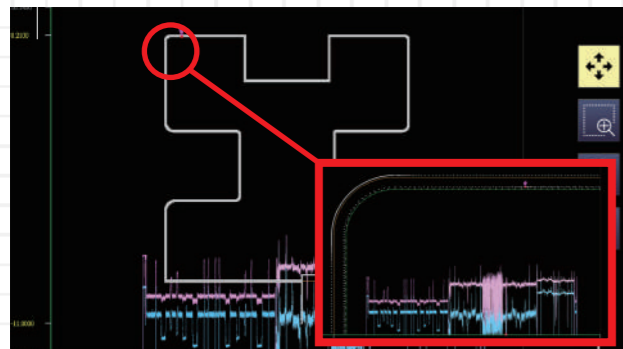

Processing history library

Processing History Search Record

The processing speed, discharge gap voltage, and other processing information are recorded by multi-tools in the whole path, and the user can quickly browse and check the processing process, Especially for the corner arc path and finishing process, the final machining result can be confirmed.

EtherCAT level control system

Dual industrial-grade PCs are equipped with high-performance CPUs and adopt Ethernet serial architecture to achieve high-speed and real-time synchronous motion. The convenient EtherCAT universal expandability enables the machine to have more intelligent applications.

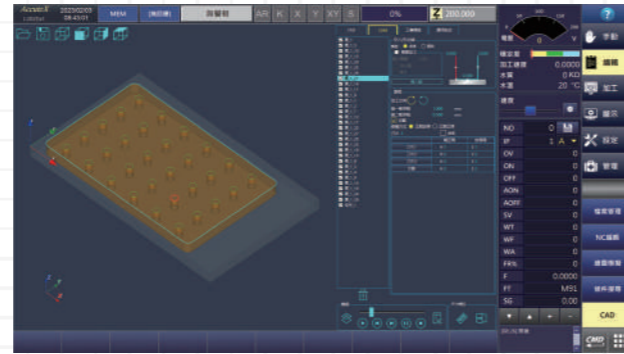

Built-in CAD/CAM

Process the complete POST-process before the cutting on the machine

The new controller has built-in the specified third-party post-processing software which supports loading the CAD drawing files. The NC program can be generated on the machine after the standard post-process.



Automatic alignment

Faster, more accurate, one-click automatic processing

Press one button to complete the automatic plate width, outer circle, inner square hole, four-sided center, and other calibration procedures. Different wire diameters can be matched with different wire tension and the wire speed settings. PICK-program is available to achieve full automation and unmanned operation. With the new edge-seeking function, the accuracy of the mold calibration is up to 3µm.



- Features of the new remote hand box
- Lightweight Design
 - Handheld ergonomics
 - Built-in LED flashlight function



EtherCAT

Screen size | 21.5 inches
Hardware device | physical, virtual keyboard
Network equipment | wi-fi



New generation of AWT, more Reliability and Repeatability.

Inherit the features of high reliability and easy maintenance of the AccuteX AWT function, the new generation has improved the straightening and wire cutting mechanism (patent pending), and equipped with a new type of straightening, annealing, and cutting power supply. This enables the wire to have better straightness and wire end quality, and achieve a higher success rate in threading through high thickness workpieces. The new mechanism is suitable for wire diameters from 0.1mm to 0.3mm(*). (*) standard brass wire.

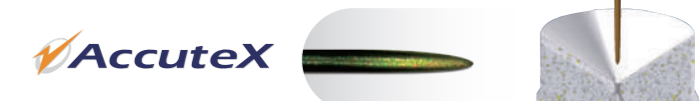

wire size 0.3 mm 0.25 mm 0.2 mm 0.15 mm 0.1 mm

X 120



X 32

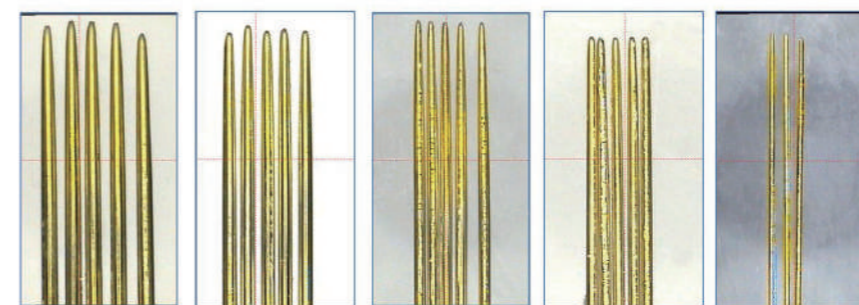

<Having Excellent wire-end in each size of wire>

Wire with AccuteX's annealing process

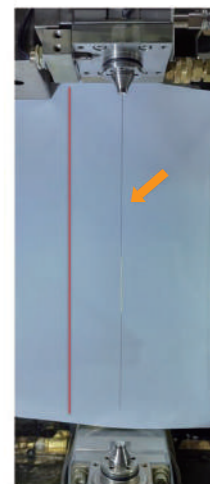

Wire without AccuteX's annealing process

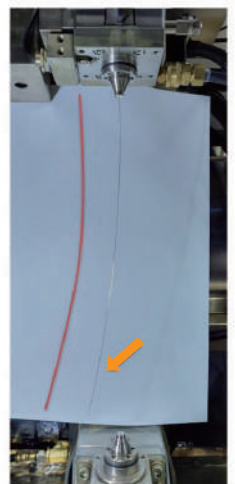

<High repeatability after wire annealing>

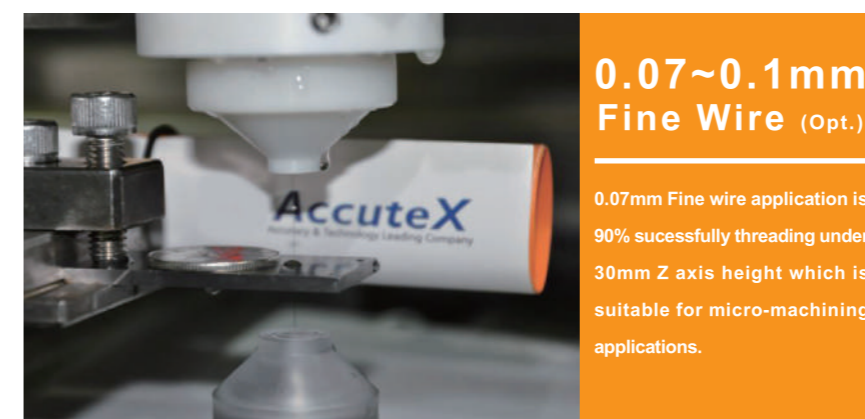

0.07~0.1mm Fine Wire (Opt.)

0.07mm Fine wire application is 90% successfully threading under 30mm Z axis height which is suitable for micro-machining applications.

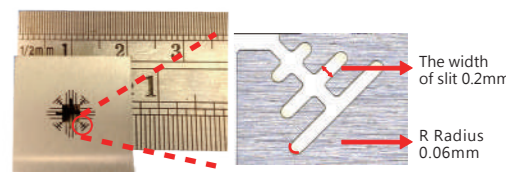

Micro Spinning Tungsten Steel Mold

Spinneret projection mold was cut by 0.07mm wire. The average width of slit is 0.2mm after 5 cuts. The smallest radius is 0.06mm.

Linear Motor

The total solution in linear motor, with the best resolution of 0.1 μ m full-closed loop servo control, non-contact transmission makes the machine backlash-free and long-term precision guarantee. The high-sensitivity response feature improves cutting speed by 8~10%. And improves operating safety with an anti-collision mechanism.

Shaft Type Linear Motor

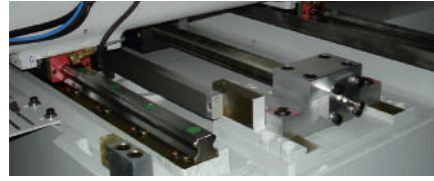

Flat Type Linear Motor

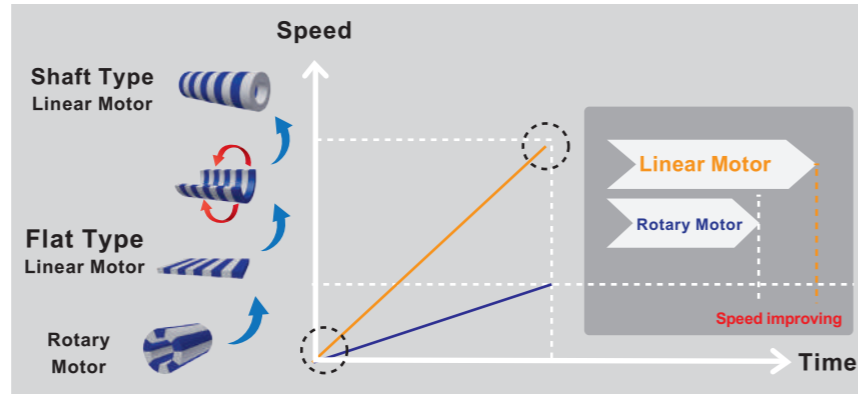
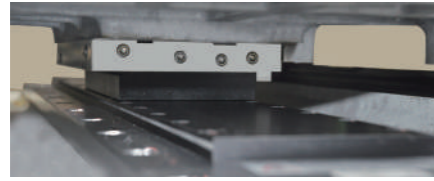

High Resolution Signal Processor

The high-resolution signal processor achieves more smooth velocity control and enhances the stability of position control. It can match up the best contouring accuracy.

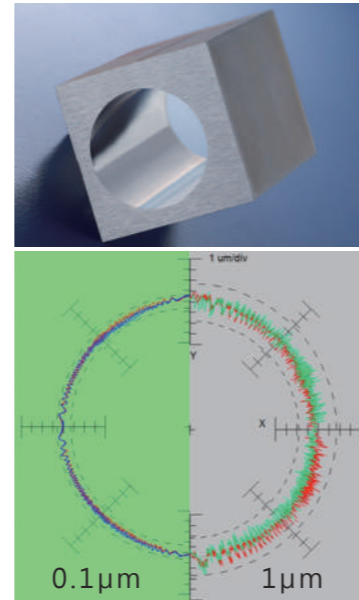
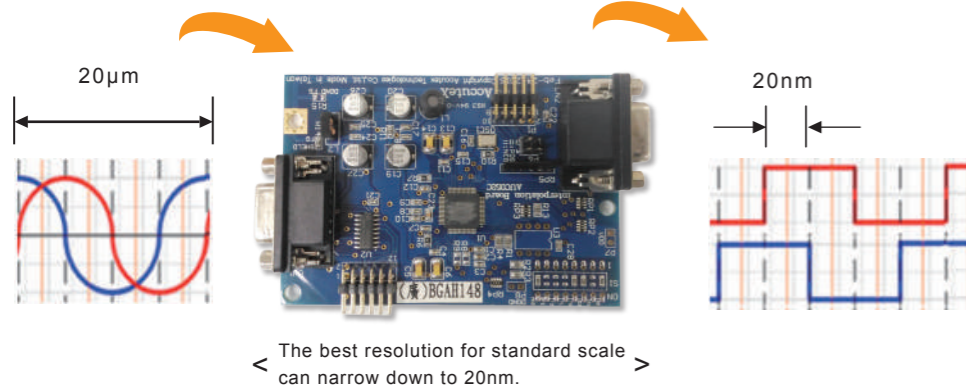

(Different Linear -Scale Resolution)

High Cutting Accuracy Performance

The best pitch accuracy is less than $\pm 3\mu$ m in 9 holes mold cutting (size: 400x300x30mm).

The working conditions are by SKD-11 material after 4 cuts under temperature and environment control.

(*) Performed by AP-4030A-0.1 μ m Linear scale

(*) The cutting conditions must follow AccuteX's provisions.

Material	SKD-11
Thickness	30mm
Passes	4 Passes

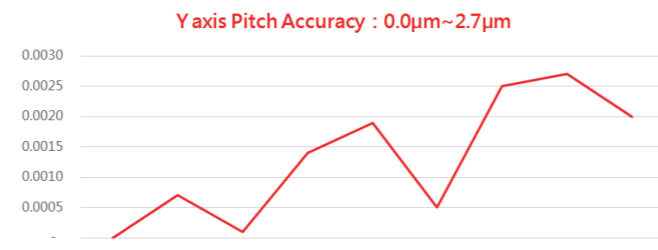
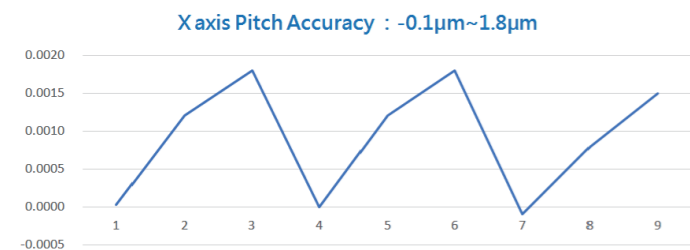
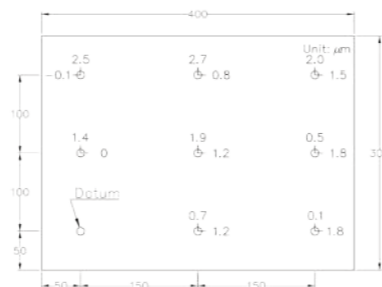

Cutting Efficiency Comparison

AccuteX has simplified the generator and electric circuits to eliminate unnecessary power loss and improve cutting efficiency. Speed comparison table with other brands in different thicknesses of workpieces.

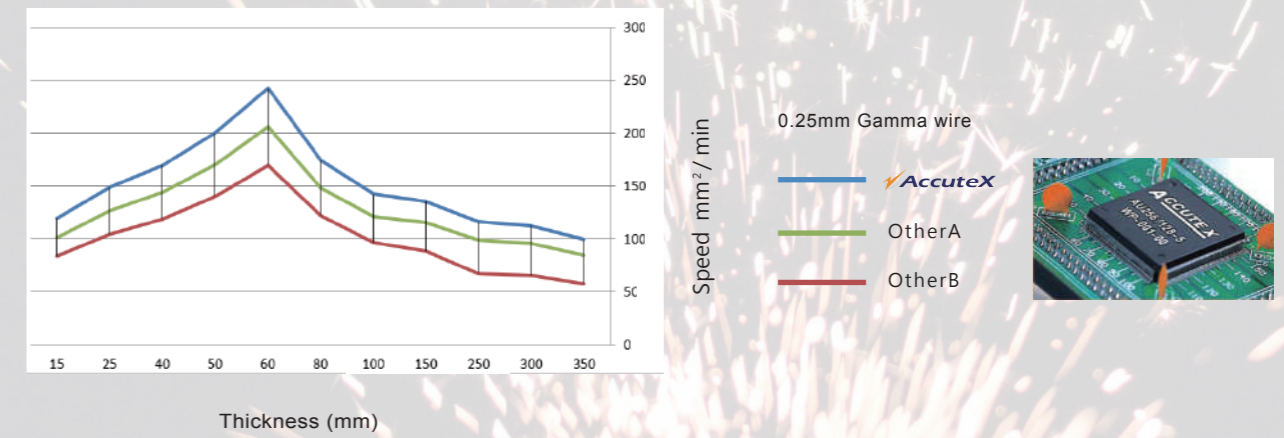

Stable Discharge Board (SD Master)



< Stable Discharge Board (SD Master) >

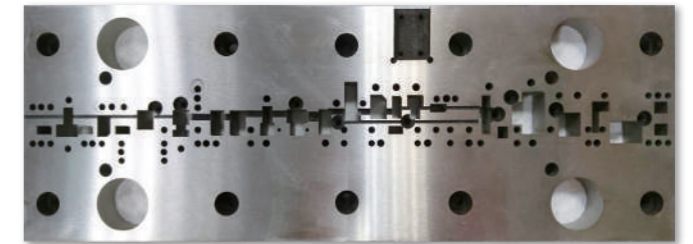

< High Precision Progressive Stamping Mold >

High repeatability

High repeatability in accuracy by applying the same cutting data on different machines, the consistence enhances the workpiece quality and simplifies management procedure.

High speed cutting

High speed cutting by SD-Master in stable discharge power which stabilize the cutting process, especially under high-speed mode.

High repeatability in accuracy

By cutting 100 holes of 6mm continuously, 95.45% of all workpieces accuracy are within $\pm 1.5\mu$ m.

Cutting conditions

Cutting conditions are made by SKD-11 with 30mm thickness by 0.25mm brass wire with 3 cuts under good temperature and environment control.

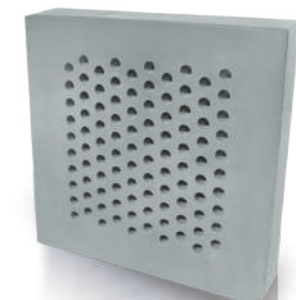
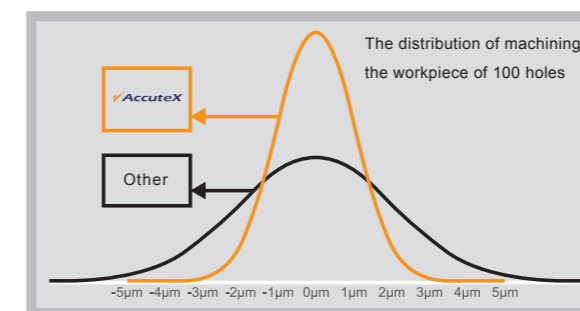

MST

Micro Sparking Technology (MST), this unique technology can reach the best Fine Finish to Ra 0.08µm on 40mm thickness Tungsten carbide material.

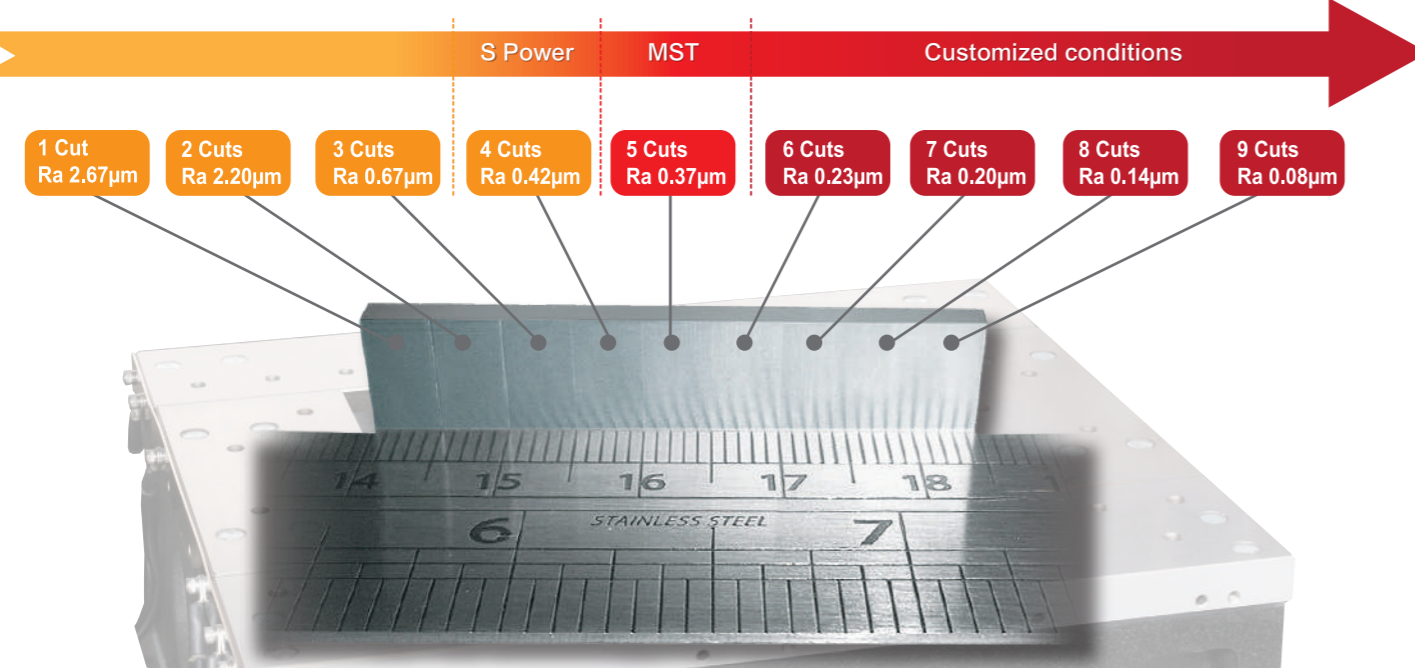

Automatic Water Level Adjustment with Z Axis

The draining plate will adjust with Z-axis height automatically. It saves operation and stabilizes the cutting, and gain a better cutting result.

PCD Cutting & Graphite machining Power Supply

The exclusive ignition circuit and stabilized discharging power supply are the most suitable design for PCD and graphite cutting; furthermore, with quality assurance for a long time machining.

The collapse of the workpiece edge by wire cut can be controlled within a minimum range along with high speed machining.

Accutex wire cut EDM can do 5 axes simultaneous interpolation, also the W axis(6th Axis rotary table) can be installed while doing complex PCD cutting tools.

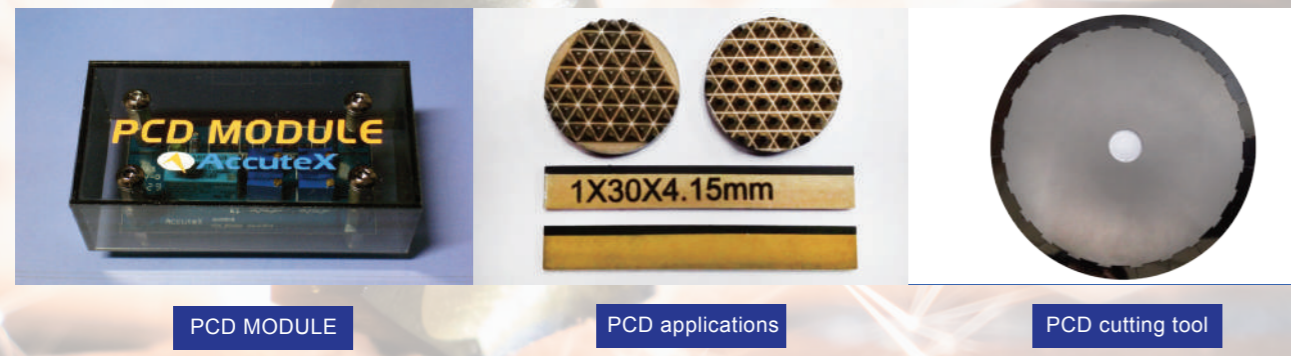

PCD MODULE

PCD applications

PCD cutting tool

Industry 4.0 Intelligent Manufacturing Integration System

Accutex machine is capable with industry 4.0 who has M2M (machine to machine) protocol to collaborate with Robots and other machines. Flexible Real-time production can be made by Intelligent Manufacturing Integration System to meet full-automation demand.

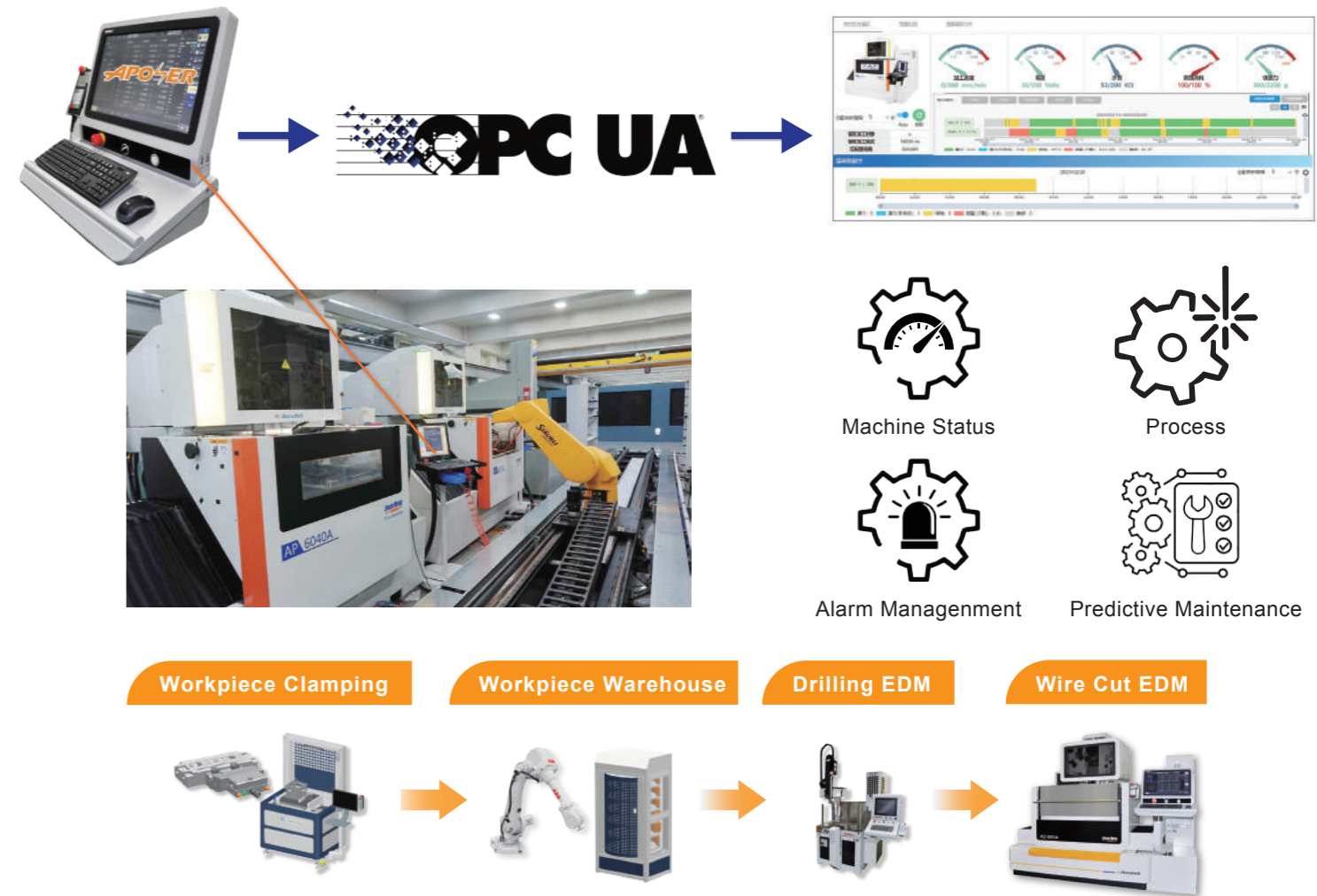

Core Remove Module

During Wire Cut EDM machining, by using the new-generation flushing nozzle to remove the core automatically can reduce human operation and increase productivity.

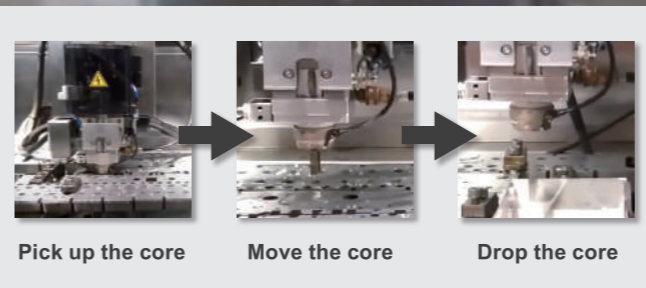

- Patented technology to remove core. Patent (No.1676513)
- Integrated with CIMFORCE intelligent manufacturing system and robot to increase productivity.
- Can integrate intelligent manufacturing system and robotic arm to further improve productivity

show video



New Line Messenger

Built-in LINE messaging system

The status of the machine is directly transmitted to the mobile device, achieving the first step of intelligent processing.

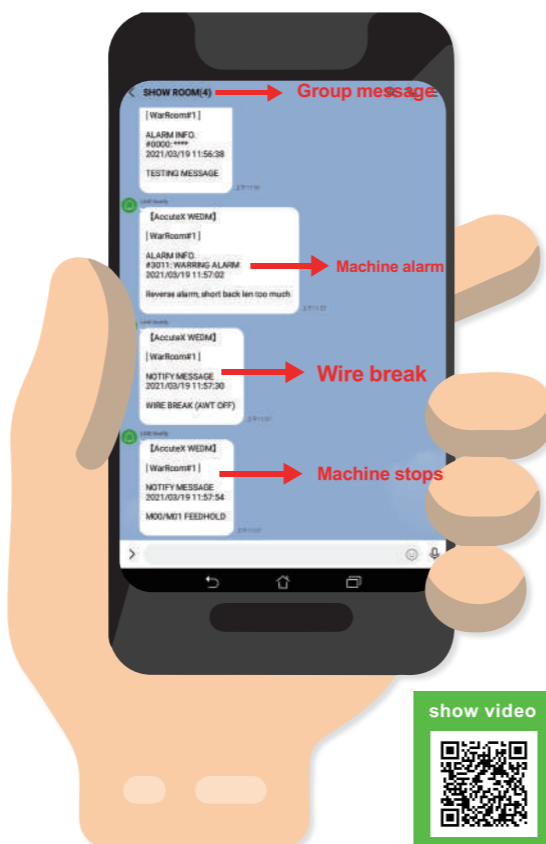
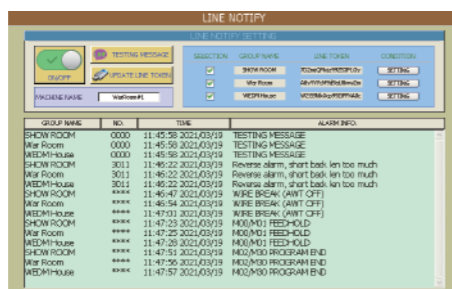

Features

- Real-time communication with the machines via common.
- APPs "Line", software expense free.
- Monitoring the cutting status remotely by your existing Line account.
- Push notification to a specific account or group.

Rotary Table Package

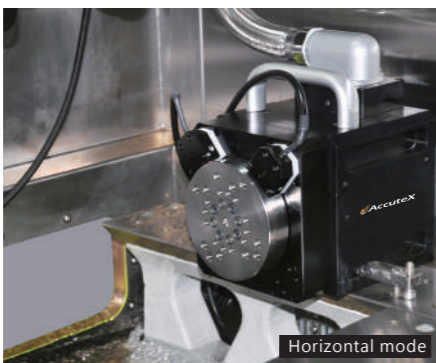
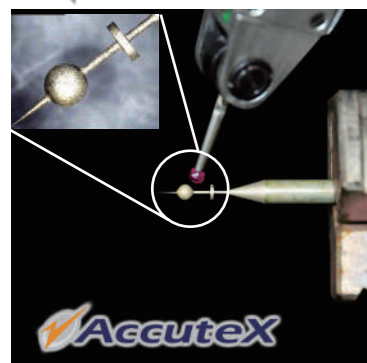

In-house design and 100% capability in submerged cutting

Accutex Rotary Table Package is leading ahead of other WEDM manufacturers by years in R&D which can be applied to the submerged operation.

High-efficiency machining

High cutting efficiency is benefited by the maximum rotation speed 1,000 RPM. Improving Fine Finish Ra to 0.2µm. The best solution for "Turn and Burn" Application for high-hardness materials, such as tungsten carbide and PCD.

Intelligent diagnostic capability

Integrating water leakage, pressure, temperature, current and other sensing systems, the signals can be Feed back to the control system, and take protective measures for power failure and shutdown in advance.

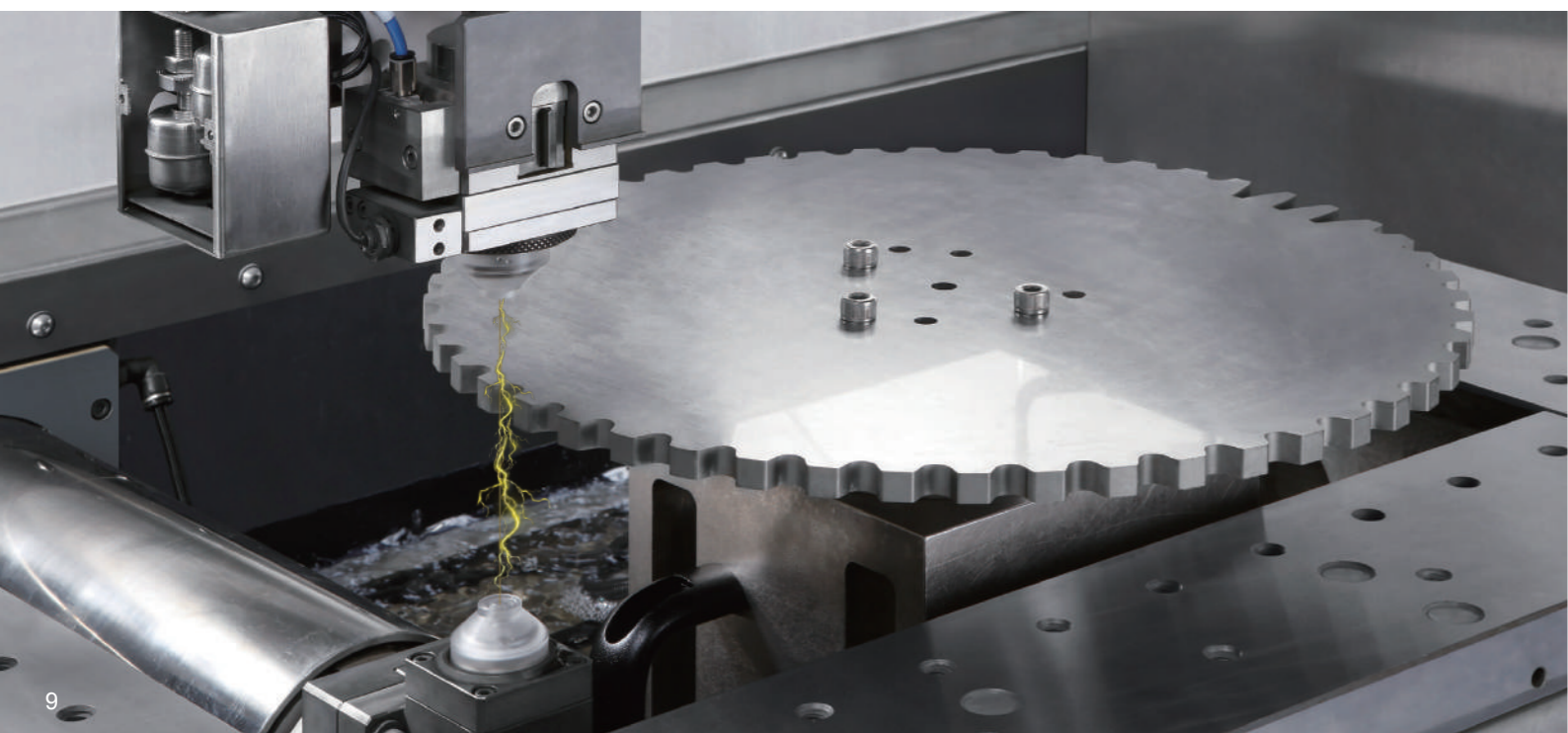

Corner & Radius Control Function

According to different wire diameters, corner angles, arc radius and thicknesses, Accutex controller optimizes parameters for the best cutting efficiency with high accuracy. Especially on the small path and continuous corners, machines can meet the corner accuracy demand.

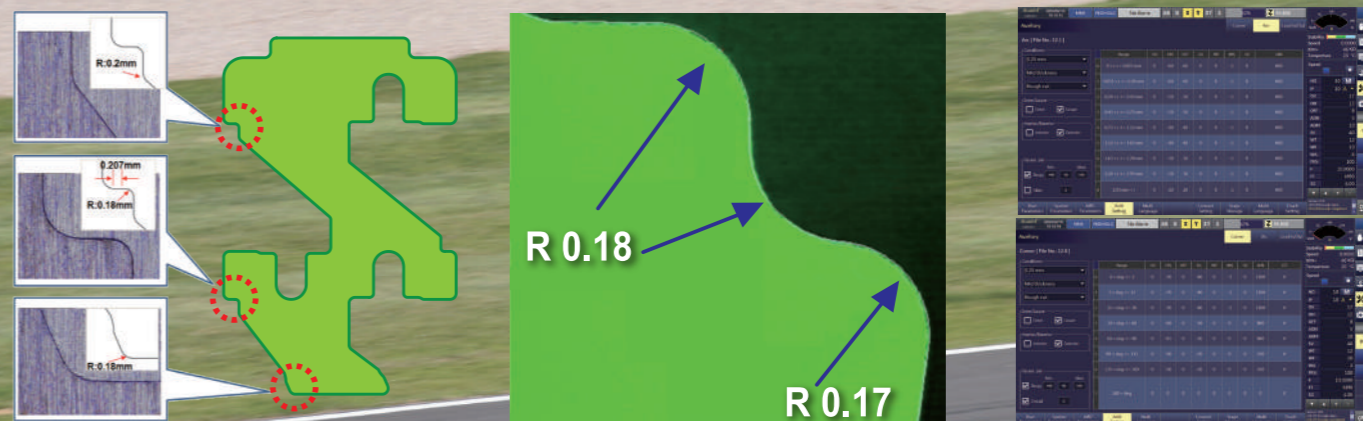

The stamping mold (Punch mold is 50mm and die mold is 30mm) has fine 3µm tolerance.

Cutting Speed :
1st Cut : 130mm²/min
2nd Cut : 260 mm²/min
3rd Cut : 320mm²/min

Wire : Ø0.25mm
Thickness : 50mm

Corner, arc control and lead-in and lead-out attack energy can be turned on and off via the controller or M-code settings



Lead-in/Lead-out control methodology

New generation of Lead-In / Lead-Out function is available for Tungsten Carbide. The wire mark is 2µm after 3 cuts by 40mm thickness which improving mold quality and saving second time polishing hours.

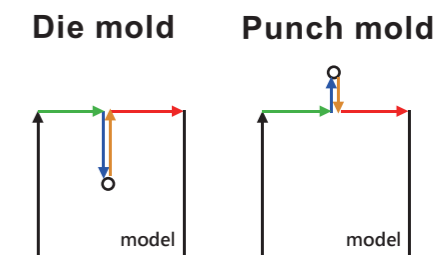
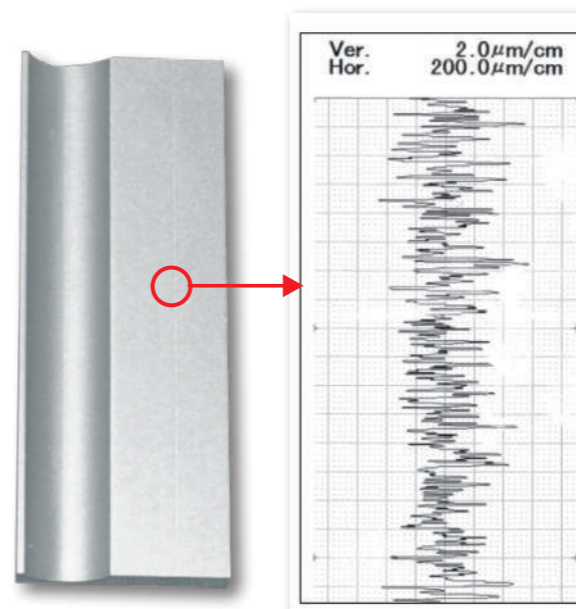

- Material SKD11
- size 0.25mm
- Thickness 50mm
- Cut 3

The depth of the depression is within the range of the surface roughness.

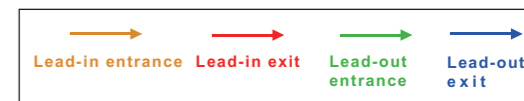

Plastic Injection Mold



- The plastic injection mold with 5μm accuracy

Material	SKD60
Thickness	30mm
Wire size	0.25mm
Cut	3

Continuous Corner & Radius



- Keeping equal tolerance in the continuous corners.
- Continuous radius is 0.18mm
- Short path is 0.207mm

Material	SKD11
Thickness	Punch:50mm / Die:30mm
Wire size	0.25mm
Cut	3

Fine Finish Ra0.06μm (Optional MST II Power Module)



- The best fine finish: Ra is 0.06μm; (Rz is 0.65~0.75μm).
- Average fine finish in 4 sides of the round die.

Material	Tungsten Carbide
Thickness	30mm
Wire size	0.2 mm
Cut	9

PCD Application (Optional PCD / Graphite Power)

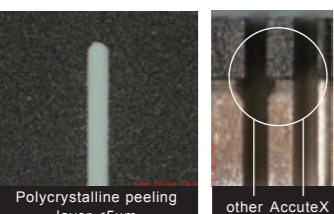

- Polycrystalline peeling layer <5μm
- Polycrystalline peeling layer is <5μm by optional PCD power with fewer grinding hours.
- Clear fit between PCD and carbide connection.

Material	PCD
Thickness	1mm
Wire size	0.2mm
Cut	1

Super Fine Spinneret (Optional Wire 0.07~0.1mm)

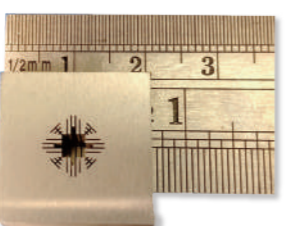

- Narrow width of the slit is 0.2mm
- Radius is 0.06mm

Material	Tungsten Carbide
Thickness	5mm
Wire size	0.07mm
Cut	5

Helical Gear Cutting (Optional Rotary Table)



- Vertical type for rotary table application
- Gear diameter is 380mm

Material	Steel
Thickness	25mm
Wire size	0.25mm
Cut	2

Aerospace parts



- Aerospace parts with hollow and extreme thin feature.
- Suitable for aerospace components, turbines, etc.
- Cutting speed is better than other competitors.

Material	Inconel
Thickness	40mm
Wire size	0.25mm
Cut	1

High-precision sleeve component



- High-precision sleeve components have a full-size accuracy of within 2 microns for all three surfaces.

Material	Steel
Thickness	75mm
Wire size	0.25mm
Cut	3

Aluminum Extrusion Mold



- With a special aluminum extrusion processing wizard, 5~40mm special database, quick to use without experience.
- Optimize discharging process and reduce the post-polishing process.

Material	H13
Thickness	10mm
Wire size	0.25mm
Cut	2

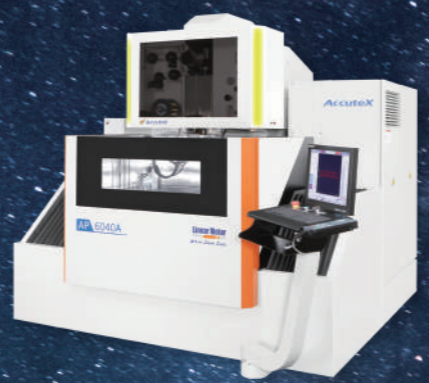

AP-4030 / 6040

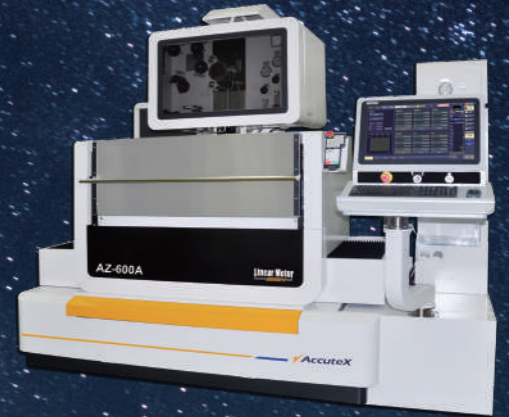

NEW AZ-400 / 600



GA-43 / 53

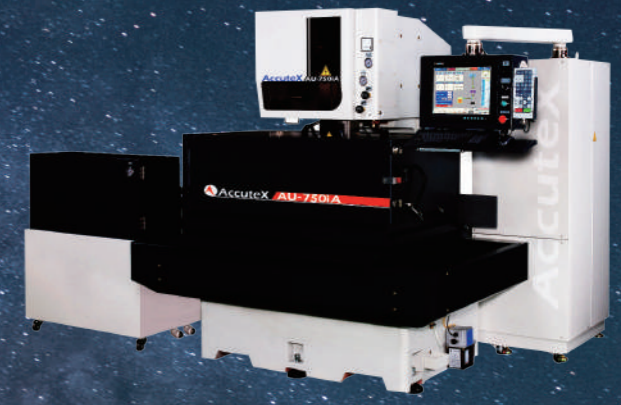

AU-750 / 900

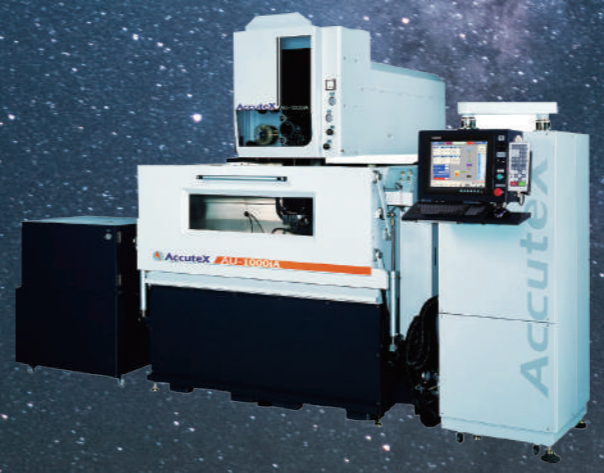

AU-860 / 1000 (Z400 / Z600)

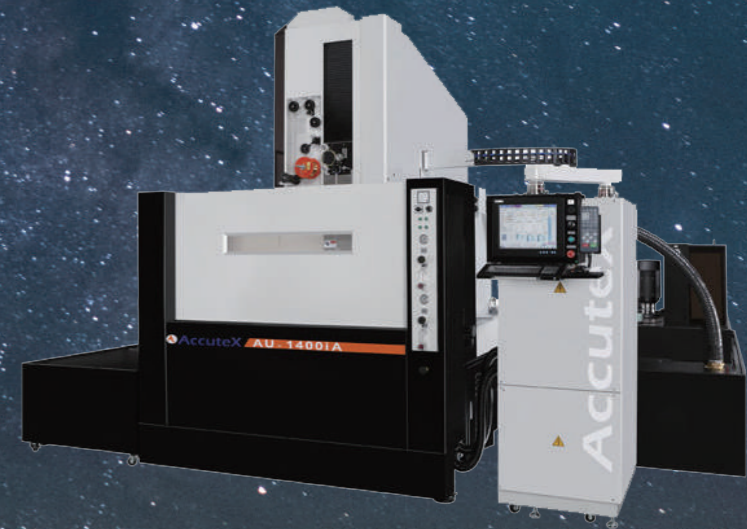

AU-1400 (Z200 / Z800)

AP | Series

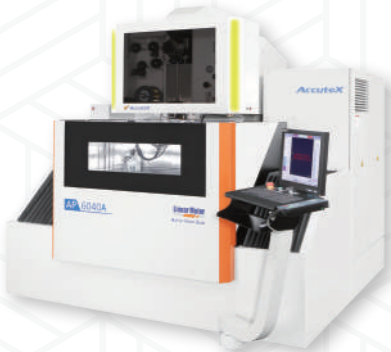

Machine Specifications			
Specifications / Models	unit	AP-4030A	AP-6040A
Max. Workpiece Size L x W x H	mm	800 x 600 x 265	980 x 775 x 345
Maximum height of cutting workpiece	mm	270	350
Max. Workpiece Weight	kg	800	1000
X / Y Stroke	mm	400 x 300	600 x 400
U / V Stroke	mm	160 x 160	160 x 160
Z Stroke	mm	270	350
Max. Cutting Taper	mm	±32° / H100mm	±32° / H100mm
Max. Wire Spool Weight	kg	16	16
Foot Print W x D x H	mm	2145 x 2750 x 2250	2320 x 2850 x 2380
Water System Capacity	L	660	980
Machine Weight	kg	5000	5100

AZ | Series



Machine Specifications			
Specifications / Models	unit	AZ-400A	AZ-600A
Max. Workpiece Size L x W x H	mm	800 x 600 x 265	980 x 775 x 295
Maximum height of cutting workpiece	mm	270	270
Max. Workpiece Weight	kg	400	550
X / Y Stroke	mm	400 x 300	600 x 400
U / V Stroke	mm	160 x 160	160 x 160
Z Stroke	mm	270	300
Max. Cutting Taper	mm	±32° / H100mm	±32° / H100mm
Max. Wire Spool Weight	kg	16	16
Foot Print W x D x H	mm	2250 x 2600 x 2280	2600 x 2700 x 2335
Water System Capacity	L	730	830
Machine Weight	kg	3500	4400

GA | Series



Machine Specifications			
Specifications / Models	unit	GA-43	GA-53
Max. Workpiece Size L x W x H	mm	880 x 630 x 215	880 x 630 x 215
Maximum height of cutting workpiece	mm	175	175
Max. Workpiece Weight	kg	400	500
X / Y Stroke	mm	400 x 300	500 x 300
U / V Stroke	mm	60	60
Z Stroke	mm	220	220
Max. Cutting Taper	mm	±15° / H80mm	±15° / H80mm
Max. Wire Spool Weight	kg	10	10
Foot Print W x D x H	mm	2200 x 2570 x 1995	2200 x 2570 x 1995
Water System Capacity	L	730	730
Machine Weight	kg	2800	3000

AU | Series



Machine Specifications			
Specifications / Models	unit	AU-750i	AU-900i
Max. Workpiece Size L x W x H	mm	1190 x 720 x 295	1335 x 760 x 295
Maximum height of cutting workpiece	mm	260	200
Max. Workpiece Weight	kg	800	800
X / Y Stroke	mm	750 x 500	900 x 500
U / V Stroke	mm	100 x 100	100 x 100
Z Stroke	mm	300	300
Max. Cutting Taper	mm	±21° / H100mm	±21° / H100mm
Max. Wire Spool Weight	kg	16	16
Foot Print W x D x H	mm	3260 x 3210 x 2300	3560 x 3050 x 2300
Water System Capacity	L	1240	1240
Machine Weight	kg	4300	5600

Machine Specifications				
Specifications / Models	unit	AU-860i	AU-1000i	AU-1400i
Max. Workpiece Size L x W x H	mm	1330 x 990 x 395	1620 x 990 x 395	1740 x 1080 x 195
Maximum height of cutting workpiece	mm	394 (605)	394 (605)	192 (800)
Max. Workpiece Weight	kg	5000	5000	4000 (10000)
X / Y Stroke	mm	800 x 600	1100 x 650	1400 x 800
U / V Stroke	mm	150 x 150	150 x 150	150 x 150
Z Stroke	mm	Z400 (Opt. Z600)	Z400 (Opt. Z600)	Z200 (Opt. Z800)
Max. Cutting Taper	mm	±30° / H100mm	±30° / H100mm	±30° / H100mm
Max. Wire Spool Weight	kg	16	16	16
Foot Print W x D x H	mm	Z400 : 3950 x 3800 x 2740 Z600 : 4300 x 3550 x 2940	Z400 : 4210 x 3800 x 2740 Z600 : 4620 x 3500 x 2900	Z200 : 4330 x 3950 x 2500 Z800 : 5110 x 4400 x 3320
Water System Capacity	L	Main Tank : 2420 (Z400) Main+Sub Tank : 1630 + 1280 (Z600)	Main Tank : 2420 (Z400) Main+Sub Tank : 1630 + 1280 (Z600)	Main Tank : 2420 (Z200) Main+Sub Tank : 2000 + 1466 (Z800)
Machine Weight	kg	7800 (8500)	8100 (8700)	7600 (10100)

Controller Specifications

Controller System	Windows	Max. Command Range	±9999.9999mm
Control Device	64 - bit Industrial PC	Command Type	mm / inch
Storage Device	≥ 30GB SSD	Cutting data Memory	99999 Sets
Screen Display Device	21.5" Color TFT Touch Screen	Power type	MOSFET Non-electrolysis power
Data Input	Keyboard, Mouse, USB, Ethernet, FTP	Ignition Power Supply	32 Steps, 53V ~ 138V
Servo control method	Full closed loop (Linear scale)	On time	24 Steps
No. of Control Axes	5 Axes / 6 Axes(Opt.W Axis)	Off time	43 Steps
Simultaneous Axes	4 Axes / 5 Axes(Opt.W Axis)	Discharge Mode	Rough Cut / Skim Cut / S Power / MST Power available for AP/AZ series only
Min. Command Unit	0.0001mm / 0.00001 inch		

Controller Functions

Backlash compensation	Pitch compensation	Program management	Program edit Program simulation
Anti-collision	Cutting path display	Linear/Circular interpolation	Auto corner
N code move	Sub program	Multi-blocks skip	Corner control function
MDI function	Taper setting	4 axes cutting	M01 stop
Single block	Mirror	program rotation	Axis exchange
Short back	Constant feed / Servo feed	2nd software limit	Axis Rotation
Auto alignment (edge, center)	Dry run	Single block stop	Reference point setting
Reference point return	Retrace to start point / Start point return	Auto Power recovery (Option)	Diagnosis
Cutting log	Maintenance dashboard	Auto compensation for wire consumption	Lead-in / Lead-Out Control

Features Specifications		AP	AZ	GA	AU
AWT System	Auto Wire Threading (AWT)	⊙	⊙	●	●
	High Pressure Water Jet Threading	●	●	●	●
	0.1 mm Wire Application	●	●	●	X
	0.07 mm Wire Application (stroke less than 400mm)	●	●	X	X
	Wire Chopper	●	●	●	●
Working Tank	45 kg Wire Jumbo Feeder	○	○	○	○
	Safety Door Interlock	●	●	●	●
Power Module	Automatic Water Level Adjustment with Z Axis	●	●	X	X
	S Power	⊙	⊙	●	●
Linear Motor System	MST Power Module	●	●	X	X
	PCD / Graphite Power Module	●	●	●	●
	XY Axes Linear Motor System	⊙	⊙	●	X
Remote Control	XY Axes 0.1μm Resolution Linear Scale	⊙	⊙	X	X
	Anti-Collision on X/Y/Z/U/V Axes	⊙	⊙	●	X
	Line Messenger	○	○	○	○
Controller Specifications	Built-in CAD/CAM	○	○	○	○
	OPC UA	○	○	○	○
	Touch Screen	⊙	⊙	●	⊙
	New Edge Finding Function	⊙	⊙	●	●
Other Accessories	Machine Status Indicator	⊙	⊙	●	●
	Rotary Table Package (W Axis)	●	●	●	●
	Auto Voltage Stabilizer	●	●	●	●
	Transformer for 440VAC	●	●	●	●
	Bridge Ruler	○	○	○	○
	Cyclone Filter	○	○	○	○
Core Remove Module	○	○	○	○	

Standard Accessories	
Upper / Lower Flushing Nozzle	Waste Wire Bin
Diamond Guide	Resin Tank
Conductor Plate	Resin
Diamond Guide Remove Jig	Paper Filter
Brass Wire	Vertical Alignment Jig
Tool Box	Water Chiller

⊙	Standard equipment
○	Can be retrofitted
●	Factory installation only
X	Not available

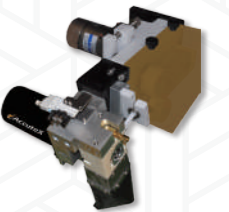

< Wire Chopper >



< Cyclone Filter > < 45Kg Wire Jumbo Feeder >

